

FBX1020[®]

FEEDBACK EXTERMINATOR[®]

OPERATING GUIDE V2

<p>QUICK-START OPERATION 1</p> <p>DECLARATION OF CONFORMITY 2</p> <p>ABOUT THE FBX-1020 3</p> <p>FREQUENCY RESPONSE 3</p> <p>WORLD'S BEST FEEDBACK CONTROLLER 3</p> <p>WHO NEEDS FBX? 3</p> <p>WHY THE FBX? 3</p> <p>DIRECT HIT ON FEEDBACK! 3</p> <p>ACTIVE/BYPASS SWITCH 4</p> <p>SIGNAL LEVEL 4</p> <p>RESET 4</p> <p>SET TOTAL NUMBER OF FILTERS 4</p> <p>SET FIXED 4</p> <p>A/C POWER INPUT 4</p> <p>AUDIO INPUTS & OUTPUTS 4</p> <p>FBX-1020 CONTROLS 4</p> <p>LOCK FIXED FILTERS 4</p> <p>FIFTH OCTAVE 4</p> <p>FILTER STAGE ACTIVITY 4</p> <p>POWER SWITCH 4</p> <p>FUSE 4</p> <p>APPLICATION DIAGRAMS 5</p> <p>FBX SETUP FOR MONITORS 5</p> <p>FBX SETUP FOR ENTIRE MIX 5</p>	<p>FBX-1020 OPERATING INSTRUCTIONS 6</p> <p>WHERE THE FBX FITS IN YOUR SOUND SYSTEM 6</p> <p>A NOTE ABOUT GRAPHIC EQUALIZERS 6</p> <p>UNDERSTANDING FIXED & DYNAMIC FILTERS 6</p> <p>CLIPGUARD™ ADAPTIVE CLIP LEVEL CONTROL 6</p> <p>CLIPGUARD™ TURBO MODE GUIDE 6</p> <p>FBX SETUP FOR SINGLE INSERT POINT 7</p> <p>FBX SETUP FOR INSERT SEND & RETURN 7</p> <p>HOW TO OPERATE THE FBX-1020 7</p> <p>HOW TO USE THE FBX-1020 FEATURES 8</p> <p style="padding-left: 20px;">USING THE LOCK FIXED FEATURE 8</p> <p style="padding-left: 20px;">SELECTING FILTER WIDTH 8</p> <p>IMPORTANT OPERATING CONSIDERATIONS 8</p> <p style="padding-left: 20px;">MEMORY 8</p> <p style="padding-left: 20px;">BYPASS MODE 8</p> <p style="padding-left: 20px;">RESETTING THE FILTERS 8</p> <p style="padding-left: 20px;">TURBO MODE SETUP 8</p> <p style="padding-left: 20px;">DEFEATING TURBO MODE 8</p> <p style="padding-left: 20px;">MOBILE VS. STATIONARY MICROPHONES 8</p> <p>FREQUENTLY ASKED QUESTIONS 9</p> <p>INDEX 9</p> <p>FBX-1020 ENGINEERING SPECIFICATIONS 10</p> <p>CAUTIONS & WARNINGS 11</p> <p>LIMITED WARRANTY 12</p>
--	---

QUICK-START OPERATION

For best results, read all operating instructions before using the FBX-1020. If you're already familiar with the FBX or just want a basic overview of FBX operation, this simple quick-start procedure is for you. More detailed instructions are on page 7 inside this operating guide.

1. Place the FBX between the output of your mixer and the input of your power amp.
2. With the master volume down, put the FBX-1020 in active mode (red BYPASS LED off), then slowly raise the mixer master volume to the point of feedback.
3. Keep raising the master volume until all of your fixed filters and one dynamic filter are set, then lower the volume slightly. (Factory default is nine fixed and three dynamic filters.) The rest of the filters continually catch and update new feedback frequencies throughout the program. You're ready to go.

READ THE ENTIRE OPERATING GUIDE FOR COMPLETE INSTRUCTIONS.

CONGRATULATIONS! You now have the state-of-the-art in feedback control. Your Sabine FBX-1020 Feedback Exterminator[®]— a single channel, 20-bit digital filtering device — gives you automatic real-time feedback control and increases the clarity and volume of your system.

The FBX-1020 incorporates the latest in digital signal processing technology. It automatically senses feedback in a sound system and determines its pitch. It then places one of 10 Constant Q micro-filters on the resonating frequency and eliminates the feedback in typically less than one second.

Special features of the FBX-1020:

- An **improved algorithm** that allows the FBX-1020 to better distinguish the difference between feedback and music
- Improved **20-bit digital resolution**, providing superior dynamic range and signal-to-noise ratio
- **10 feedback filters**, giving the unit more feedback elimination power for the toughest venues.
- **ClipGuard™ adaptive clip level control, with TURBO setup mode**, increases the effective dynamic range by more than 10dB and makes setup faster and easier.
- Standard FBX features such as **lockable fixed filters** and **switchable 1/10- and 1/5-octave Constant Q filters** are also included and now have convenient front panel switches.

DECLARATION OF CONFORMITY

Application of Council Directive: 73/23/EEC and 89/336/EEC

Standard to which conformity is declared:

EN 60065:1993

EN 50082-1:1992

EN 55022 Class B

Manufacturer's Name: Sabine, Inc.

Manufacturer's Address: 13301 Highway 441
Alachua, FL 32615-8544 USA

Type of Equipment: Equalizer

Model No.: FBX-1020

Serial No.:

Year of Manufacture: 1997 and on

I, the undersigned, hereby declare that the equipment specified above conforms to the above Directive and Standard.

Place: Alachua, Florida, USA

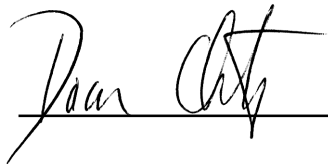
Signature: 

Date: October 4, 2000

Full Name: Doran Oster, Sabine President

ABOUT THE FBX-1020

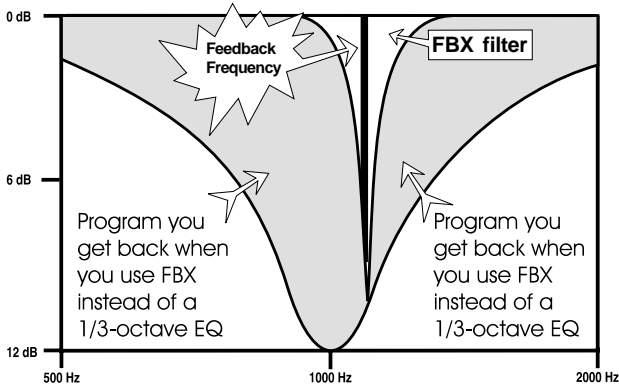

FREQUENCY RESPONSE: FBX 1/10-Octave Filter Vs. 1/3-Octave Graphic EQ Filter (12 dB depth; Log Scale).

Direct Hit on Feedback!

The FBX targets feedback without taking a big chunk out of your sound. Tests prove that a single 1/3-octave EQ slider pulled down 12 dB removes almost half the power going to the speakers over a two-octave range. And, as this illustration shows, you can't place a graphic EQ filter precisely on the ringing frequency. When you pull down multiple sliders in a normal setup (below), you end up with giant holes in your music. On the other hand, FBX micro-filters are 10 times narrower - you get back up to 90% of the power you lose with a graphic EQ! That means more gain before feedback and no loss in sound quality.

Frequency Response

Full Set-Up FBX Vs. 1/3 Octave Graphic Equalizer. Test procedure: A PA system was set up using a microphone, mixer, FBX, power amp and two speakers. The system's gain was raised until the FBX removed nine feedback points. Next, the FBX was replaced with a 1/3 octave graphic EQ. The EQ was adjusted while the system gain was raised to the same level achieved with the FBX. The frequency response curves of each device were then plotted.

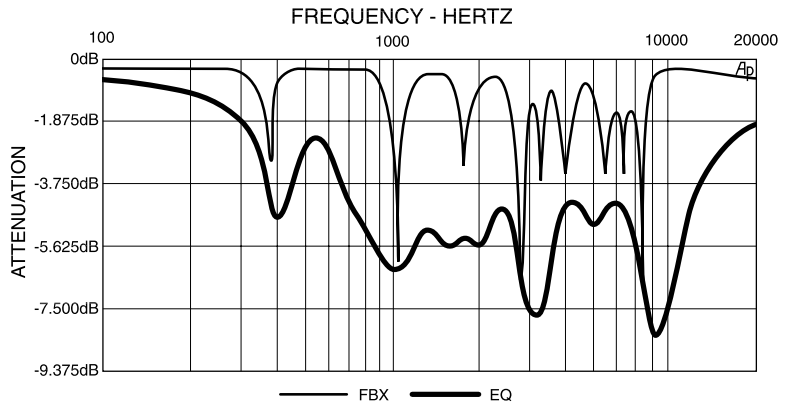

World's Best Feedback Controller

Before the invention of the FBX, the most common device for controlling feedback was the 31-band graphic EQ. However, the FBX has three distinct advantages. The most obvious is the FBX functions automatically, even during the program. Another is the FBX micro-filters are precisely placed while EQ filters are fixed. The difference: FBX filters do not have to be as deep, so there is more system gain. The most important advantage is that FBX micro-filters are ten times narrower than 31-band EQ filters. FBX micro-filters return up to 90 percent of the power removed by EQ filters.

Over the years, engineers stopped using 12-band EQs in favor of the narrower-filter 31-band EQ for controlling feedback. The FBX represents the next step. An EQ would need more than 10,000 sliders to be equivalent to your FBX. With the FBX-1020, your monitors will finally sound loud enough, everyone in the audience will understand each word, and the mains will sound natural and transparent.

Who Needs FBX?

Virtually every sound system will be improved with the FBX. Small bands that do not have sound technicians can now increase their monitor volumes so they can hear themselves clearly and with full fidelity, without worrying if the program is going to be ruined by feedback.

Auditoriums and churches of all sizes will enjoy reliable feedback control. Hotels and conference centers around the world can offer meeting rooms with sound systems that won't howl during programs. The FBX-1020 can be installed in theaters, schools, sports arenas, courtrooms — anywhere multiple microphones are used. It can also be used for teleconferencing, intercoms or interactive remote classrooms.

Why the FBX?

The simple beauty of the FBX is its ability to quickly and effectively eliminate feedback with narrower filters than ever before possible. The FBX delivers superior sound quality automatically.

FBX-1020 CONTROLS

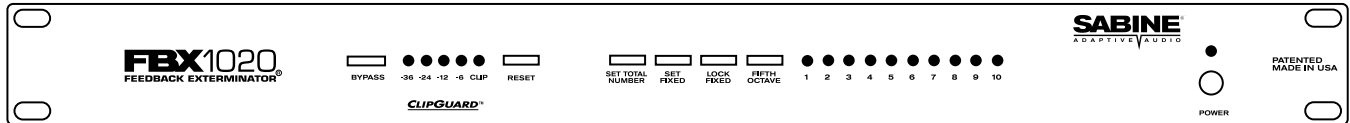

FBX-1020 Front Panel

Active/Bypass Switch

Bypass mode takes the unit out of the signal path so that it will have no effect on the program. In active mode, the unit controls feedback automatically. The red BYPASS LED lights when the unit is in bypass mode.

Signal Level

The LED ladder indicates the signal strength relative to the FBX's input clip level. The red CLIP LED indicates clipping; it also indicates the unit is in TURBO mode.

Reset

To reset ALL filters, hold the reset button for 4 seconds until all filter LEDs are off.

Set Total Number of Filters

To set the total number of filters, depress the button for 4 seconds and then release. The LEDs will begin to light in sequence. When the LED corresponding to the desired number of filters lights, press the button to register your selection.

Set Fixed

To set fixed filters, hold down the button for 4 seconds and then release. The LEDs will begin to light in sequence. When the LED corresponding to the desired number of fixed filters lights, press the button to register your selection. (Factory default is nine fixed and three dynamic filters.)

Lock Fixed Filters

When the LOCK FIXED button is pressed, its LED will light to indicate that the FBX is in LOCK FIXED mode. LOCK FIXED mode can be activated at any time after system setup and will stay on until the button is pressed again and the LED turns off. Engaging the LOCK FIXED button also takes the FBX-1020 out of ClipGuard's TURBO setup mode.

Fifth Octave

Press the button at any time to select wider filters for any new filters to be set. It is possible to have both 1/5 and 1/10 octave Constant Q filters active in one channel simultaneously.

Filter Stage Activity

When one of the unit's 10 filters is activated, the corresponding LED lights. A blinking LED indicates the filter that was most recently activated.

Power Switch

The ON/OFF switch is a two-position push button switch. The power indicator LED will light when the FBX is operational.

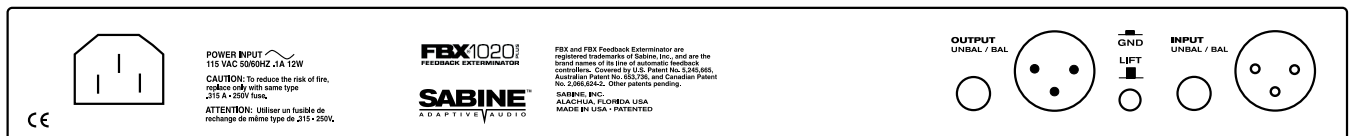

FBX-1020 Back Panel

A/C Power Input

The FBX-1020 is factory configured to operate at either 115 VAC or 230 VAC. Using the wrong input voltage may cause permanent damage to the unit and will void the warranty.

Audio Inputs & Outputs

1/4" TRS and XLR balanced and unbalanced.

Fuse

This equipment is fitted with an IEC power inlet incorporating a built-in fuse holder. To change the fuse in this socket:

1. Disconnect the power cord from the unit.
2. Pull out the fuse holder and remove the old fuse.
3. Install the new fuse into the holder. Replace only with 5x20mm, 0.315A, 250V F (fast acting) fuse.
4. Refit the fuse cover.

APPLICATION DIAGRAMS

FBX Setup for Monitors

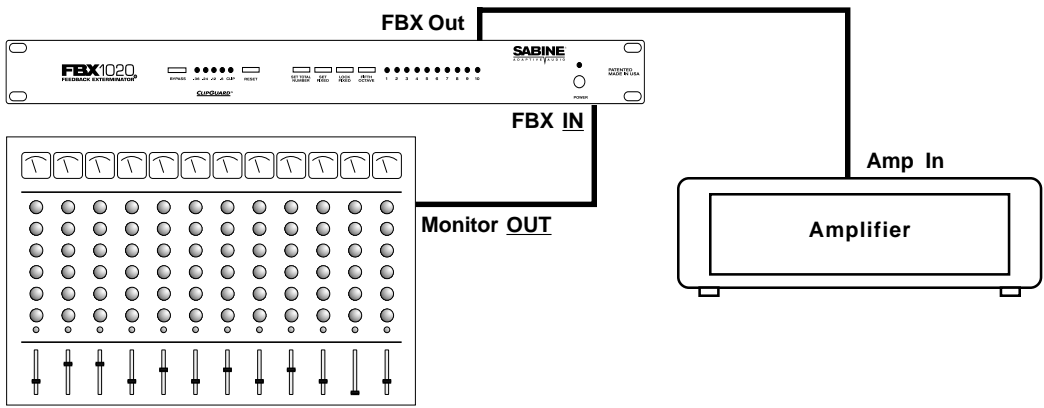

FBX Setup for Entire Mix

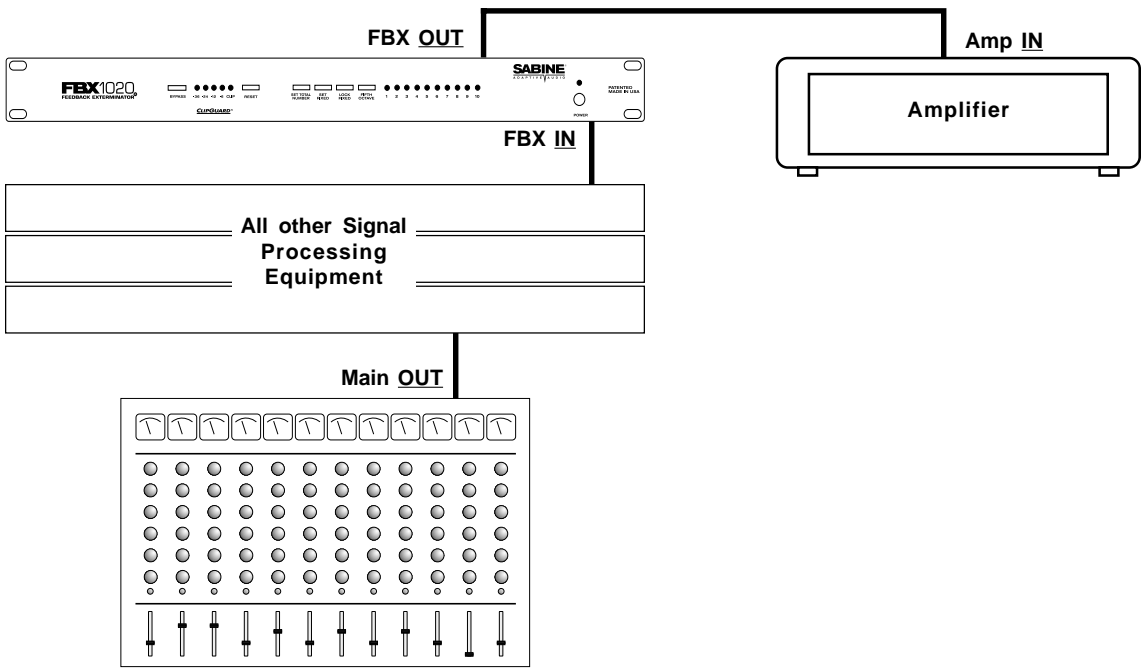

FBX Setup for Single Insert Point

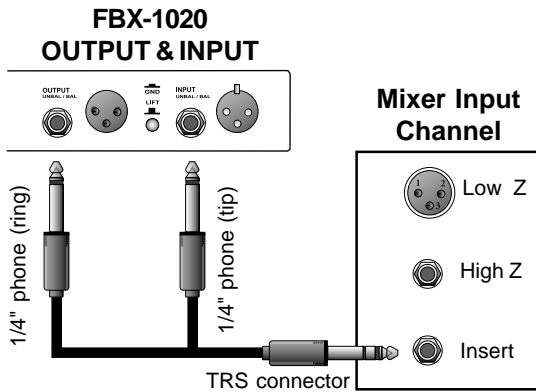

Note: If you're using a mixer with unbalanced 1/4" outputs, you must use standard unbalanced cables and connectors when connecting it to the FBX. Similarly, if your mixer is wired for balanced 1/4" (Ring/Tip/Sleeve) outputs, you must use that type of connector. If you don't, you may experience a loss of gain when using the FBX.

The FBX is designed for balanced output. If either side of the balanced output is grounded at any point, a 6 dB loss in dynamic range may occur (+21dBV max. signal level unbal.; +27dBV max. signal level bal.).

FBX Setup for Insert Send & Return

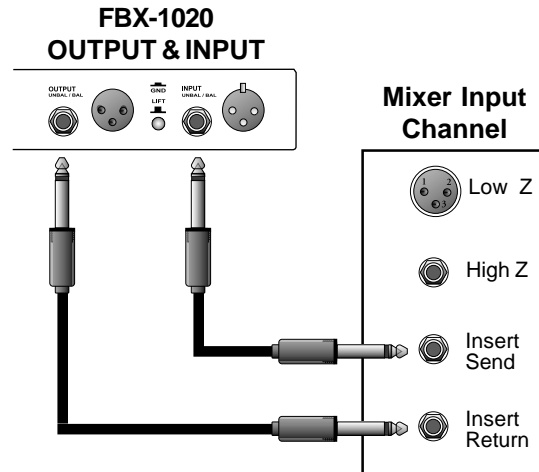

Use 1/4" TRS plug for balanced sends/inserts

Use 1/4" TS plug for unbalanced sends/inserts

FBX-1020 OPERATING INSTRUCTIONS

Where the FBX fits in your sound system

Place the FBX anywhere in the sound system that a graphic equalizer might be used to control feedback. The most common place is between the output of the mixer and the input of a power amp. In this position, the FBX can sense and eliminate feedback occurring in any channel of the mixer. The FBX can also be used on a mixer insert point.

A note about graphic equalizers

Graphic EQs are excellent for shaping sound, and they are fairly simple to use. However, using one-octave-wide EQ filters to control feedback invariably causes an unnecessary decrease in the gain and fidelity of the program. It's easy to see that if feedback occurs somewhere between the sliders, you will have to pull one of those EQ sliders down pretty far to eliminate feedback. That pulls out plenty of your program, too. On the other hand, you'll get considerably more net gain and much better sound quality if you use wide graphic EQ filters for tone control and insist on narrow filters for feedback control.

If you use an equalizer, place the FBX after the EQ in the signal path. Use the EQ's controls to shape the tonal response of the sound system, but **DO NOT NOTCH FOR FEEDBACK**.

Understanding FIXED & DYNAMIC filters

Before operating the FBX, you need to understand the two types of FBX filters: FIXED and DYNAMIC. FIXED FILTERS retain their frequency center-points until the unit is reset by the user. The system's gain before feedback is limited primarily by the number of fixed filters; i.e., increasing the number of fixed filters increases the system's gain before feedback. The FBX's DYNAMIC FILTERS control intermittent feedback that comes and goes throughout the program. They are

continually reset automatically to different frequencies as new feedback occurs during the program. For most applications, the optimal setting is nine FIXED and three DYNAMIC FILTERS. This is the factory default.

ClipGuard™ Adaptive Clip Level Control

Your FBX-1020 has a powerful new feature: Sabine's patented ClipGuard™ adaptive clip level control. Until Sabine invented ClipGuard™, engineers had to set audio equipment input and output levels to a compromised setting that allowed too much noise in quiet programs and risked clipping during high-level programs. With ClipGuard™, no front panel program level control is needed. It automatically matches the FBX-1020 internal dynamic range to the constantly changing program level and maintains unity gain. ClipGuard™ extends the effective dynamic range of your FBX-1020 from 100dB to 105dB!

ClipGuard™ incorporates TURBO mode setup, another new feature. It cuts the time for FBX filter initialization to just a few seconds, and it greatly reduces the volume level of the feedback during setup. **The FBX-1020 is set in TURBO mode at the factory and automatically engages every time you press RESET or SET TOTAL NO (to reset filters or set total number of filters). The FBX-1020 automatically returns to normal program mode when the first dynamic filter is set or when you press the front panel LOCK FIXED button. ALL FILTER LEDS WILL CYCLE TO INDICATE THE FBX IS ABOUT TO EXIT TURBO MODE.**

How To Operate The FBX-1020



Follow these steps to obtain the maximum gain before feedback without changing the tonal quality of your program.

1. Place the speakers and microphones in the positions where they will be used during the program. Avoid placing microphones directly in front of speakers.
2. If you possess any equipment in the signal path with a noise gate, you MUST DISENGAGE these noise gates prior to the setup procedure. You may reengage these noise gates upon conclusion of your FBX setup. (It is also recommended to disengage compressors in the signal path)
3. Set the master volumes to their lowest positions. Turn on the mixer, then the FBX (make sure the FBX is in BYPASS mode, with the red BYPASS LED on), then any other accessories and finally the power amp. If you are using a graphic EQ, adjust only for the desired tonal qualities, but DO NOT NOTCH FOR FEEDBACK. Adjust the balance for each mixer channel, and set the sound system's master volume to minimum.
4. Press RESET until all LEDs stop flashing.
5. You may set the total number of filters you want to activate (factory default is 10 filters - skip to #6 if default is OK for your application) by holding down the SET TOTAL NO. button for 4 seconds. The LEDs will blink 4 times and then go out. Release the SET TOTAL NO. button. The LEDs will begin to light in sequence. When the LED corresponding to the desired number of filters lights, press the SET TOTAL NO. button. You've successfully set the total number of filters.
6. Now set the number of fixed filters you need (factory default is 7 fixed and 3 dynamic - skip to #7 if default is OK for your application). Depress the SET FIXED button for 4 seconds. The total number of enabled filters set in step 5 will blink 4 times and go out. Release the SET FIXED button, and the LEDs will begin to light in sequence. When the LED corresponding to the desired number of fixed filters lights, press the SET FIXED button. You've successfully set the number of fixed filters.
7. Press BYPASS to put the FBX in active mode (red LED off).
8. Slowly raise the sound system's master volume until feedback occurs. The FBX will quickly remove the feedback. The first FILTER LED will then blink to indicate a filter has been set. Repeat this procedure until all of the FIXED FILTERS and one of the DYNAMIC FILTERS are set. (The Clip Level mode LED will go off.)
9. Now lower the master volume slightly so that the system is not on the verge of another feedback point. This is the maximum volume level that the FBX will be able to provide. Higher levels will cause uncontrollable feedback.
10. You're ready to go. ClipGuard™ will automatically match the input level to the best internal dynamic range.

How To Use The FBX-1020 Features

IMPORTANT TIP

You can mix 1/10- and 1/5-octave filters in the same channel. If you have an especially bad feedback problem, try making the first few filters 1/5-octave and the remaining filters 1/10-octave.

ClipGuard™ TURBO Mode Guide

What is TURBO mode?	TURBO mode speeds up the FBX filter initialization process so that it takes only a few seconds, and it greatly reduces the volume level of the feedback during setup.
How do I know TURBO is on?	If the red CLIP LED flashes when no other signal level LEDs are on, TURBO is on.
How do I turn off TURBO?	TURBO turns off automatically after the first dynamic filter is set, or you can turn it off manually by pressing the LOCK FIXED button. (Press it again to unlock the filters.)
Can the 1020 work during the program with TURBO on?	NO! TURBO mode should be turned off either automatically or manually before your program begins. If left on, the 1020 will clip, may set FBX filters improperly.
Why won't all the fixed filters set?	If you press LOCK FIXED to turn off TURBO mode before all the fixed filters have been set, and you want to use the rest of the fixed filters, press LOCK FIXED again right away before a dynamic filter sets. Once a dynamic filter sets, you will not be able to use the rest of the fixed filters unless you reset and start the initialization again.

NOTE: If you press LOCK FIXED to turn off TURBO mode before all the fixed filters have been set, and you want to use the rest of the fixed filters, press LOCK FIXED again right away — before a dynamic filter sets. Once a dynamic filter sets, you will not be able to use the rest of the fixed filters unless you reset and reinitialize the unit.

WARNING: Follow the setup procedure outlined on the left, and do not play audio program during TURBO setup mode. Otherwise, the FBX-1020 will clip and may set FBX filters improperly. (Clip level is set to the lowest level so the feedback clips quickly; therefore, your program will also be clipped in TURBO mode. Be sure a dynamic filter is set, and if one isn't, press the LOCK FIXED button before your program begins. Press LOCK FIXED again if you want FIXED filters to remain active.) You'll know the 1020 is in TURBO mode if the red CLIP LED flashes when no other signal level LEDs are on. (See "How do I turn off Turbo?" in the ClipGuard TURBO Mode Guide above.)

NOTE: Any loud sounds picked up by open microphones while TURBO is engaged may cause FBX filters to set. For this reason we recommend maintaining silence as much as possible during the short time TURBO is engaged.

If your venue is too noisy to take advantage of TURBO mode, turn off TURBO by pressing LOCK FIXED on, then off before you initialize for feedback. Remember: if you leave LOCK FIXED on, the fixed filters won't initialize. The LED indicating LOCK FIXED should be off when initializing.

Using the LOCK FIXED feature

In very few situations the FBX may mistake music for feedback and drive the fixed filters deeper than necessary, such as in a church with a pipe organ, or during a performance with a great deal of intentional sustained electric guitar feedback. You can prevent the fixed filters from deepening beyond their preset depth by pressing the LOCK FIXED button on the front panel after setup. The LOCK FIXED LED will light to indicate that the FBX is in LOCK FIXED mode. The fixed filters stay locked until you press the LOCK FIXED button again.

Selecting filter width

If you're using the FBX for a music application, the standard 1/10-octave Constant Q filter is usually preferable. However, in spoken word applications, such as lectures or teleconferencing, we recommend using the wider 1/5-octave filter for more robust feedback control. You may enable the 1/5-octave filters by pressing the "FIFTH OCTAVE" button, and the built-in LED will light. Only filters set after pressing the button in will be 1/5-octave. Press the button again to set subsequent filters to standard 1/10-octave filters. You can mix filter widths in the same channel (see "IMPORTANT TIP" below).

Important Operating Considerations

Memory

The FBX stores the positions and depths of the filters in nonvolatile internal memory when the unit is turned off or during a power failure. The unit will return all filters to their previous frequencies and depths when it is turned back on.

Bypass Mode

The FBX has a true power-off bypass. The signal is unaffected in BYPASS MODE even if the unit is turned off. **Please note that if a combination of BALANCED and UNBALANCED inputs and outputs is used, the signal may be disconnected in BYPASS MODE.**

Resetting the filters

The user must reset the FBX if the microphones or speakers are moved significantly. To reset the unit, place the PA system's master volume to minimum and then press the RESET button until the LEDs flash about 4 seconds — and the FILTER LEDs stop flashing. Then follow the system initialization procedure explained previously.

TURBO Mode Setup

The FBX-1020 incorporates TURBO mode setup, which is indicated by a flashing red "CLIP" LED. This lightning-quick setup feature cuts the time for FBX filter initialization to just a few seconds, and it reduces the volume level of the feedback during setup. **The 1020 is set in TURBO mode at the factory and automatically engages every time you press RESET (resetting filters). The 1020 automatically returns to normal program mode when the first dynamic filter is set or when you press the front panel LOCK FIXED button. ALL FILTER LEDS WILL CYCLE TO INDICATE THE FBX IS ABOUT TO EXIT TURBO MODE.**

WARNING: TURBO Mode will cause distortion in your audio program — it is for setup only. You must follow the setup procedure outlined in the previous section, and do not play program during TURBO setup mode. Otherwise the 1020 will clip, and filters may be set improperly. (Clip level is set to the lowest level so the feedback clips quickly; therefore, your program will also be clipped in TURBO mode. Be sure a dynamic filter is set, and if one isn't, press the LOCK FIXED button before your program begins.) **You'll know the 1020 is in TURBO mode if the red CLIP LED flashes when no other signal level LEDs are lit.**

Defeating Turbo Mode

You can manually override TURBO mode if necessary: Press LOCK FIXED (the LOCK FIXED light will turn on), then press it again. (LOCK FIXED light will go out).

Mobile vs. Stationary Microphones

One significant advantage offered by the Sabine family of FBX feedback eliminator products is their ability to adapt to changing acoustical relationships involving sound system components and various user applications. One major source of potential feedback problems arises in situations with wireless microphones, when the user of the wireless mic is moving around the stage/auditorium. As a microphone moves in a sound space, with varying degrees of proximity to the speakers and varying acoustic responses, feedback frequencies may shift. In such a situation, feedback-free mobility may be more important a concern than maximum system gain.

One method of setting FBX filters with mobile microphones is to turn a microphone on and walk around to the various possible microphone locations. At the same time, raise the system gain and set the FBX filters one at a time.

In some situations, raising the number of dynamic filters (versus fixed FBX filters) may allow a second layer of defense against new feedback from new locations. However, in many mobile microphone set ups, fixed FBX filters will protect against feedback across the range of microphone mobility.

FREQUENTLY ASKED QUESTIONS

Q. Can I place the FBX in the mixer's EQ loop?

A. Yes.

Q. Can I place the unit in the mixer effects loop?

A. Avoid this configuration if possible. You can configure the system this way *only* if each effects send of each mixer channel is set so that all of the signal is routed completely through the effects loop. You cannot mix dry signal with effects signal and still control feedback.

Q. The signal input LEDs do not light. The unit will not catch feedback. Why?

A. The unit is not in the signal path. Check the connections. Be sure that the program is interrupted when the input is disconnected from the back of the unit.

Q. Can I mix balanced and unbalanced inputs and outputs?

A. Yes. An unbalanced input and balanced output are compatible. However, a balanced input and unbalanced output may result in a 6 dB loss of dynamic range, and the bypass function may not operate correctly.

Q. Why does one of the FILTER ACTIVITY LEDs blink?

A. The last filter to be automatically updated blinks. During normal operation, the blinking will move from filter to filter as they are reset. This gives the user a visual confirmation that the unit is responding to new feedback and is functioning properly.

Q. Sometimes during the initial setup, the first filter LED will blink before any feedback has been introduced into the system. Why?

A. The FBX will set a filter if the system has a hum. Check for bad grounds. Try resetting the filters.

Q. Why does the FBX cause a noticeable hum?

A. It hums if the main power voltage drops significantly below 10% of the specified voltage. Check the A/C power mains.

Q. Why does my system sound thin and muffled?

A. Place the FBX in BYPASS MODE. If the system still sounds thin, your problem is probably with improper use of a graphic EQ. If the problem is really the FBX, reinitialize the system.

Q. Why does my program sound clipped and distorted?

A. Make sure the FBX's TURBO mode has turned off before your program begins. Check the signal level ladder. If the red CLIP LED flashes when no other signal level LEDs are on, the FBX-1020 is still in TURBO mode. TURBO mode turns off automatically after the first dynamic filter is set, or you can turn it off manually by pressing the LOCK FIXED button.

Q. Why won't the rest of the fixed filters set after I press LOCK FIXED to turn off TURBO mode?

A. If you press LOCK FIXED to turn off TURBO mode before all the fixed filters are set, and you want to use the rest of the fixed filters, press LOCK FIXED again *before* a dynamic filter sets. Once a dynamic filter sets, you will not be able to use the rest of the fixed filters unless you reset the unit and start initialization again.

INDEX

Symbols

1/10 Octave Filter 3, 4, 6, 8

1/3 Octave Filter 3

1/5 Octave Filter 4, 6, 8

A

Adaptive Clip Level 6

B

Balanced/Unbalanced IN/OUT 4, 7, 8

Bypass 4, 7, 8

C

ClipGuard 4, 6, 7

D

Dynamic Filter 4, 7

F

Filter LEDs 4, 6, 8

Fixed Filter 4, 6, 7

Fuse 4, 10, 11

L

Lock Fixed 4, 6, 7, 8

M

Master Volume (System) 7, 8

Microphone 3, 7, 8

Music Application (for FBX) 8

P

Pipe Organs & FBX 8

R

Reset 6, 7, 8

Reset (dual function) 4

S

Send & Return 7

Set Fixed 4, 7

Set Total Number of Filters 6, 7

Spoken Word Application (for FBX) 8

T

Turbo Mode 4, 6, 7, 8

V

Voltage 4, 11

W

Wireless Microphones 8

FBX-1020 ENGINEERING SPECIFICATIONS

FILTERS

10 independent digital notch filters, controlled automatically from 40 Hz to 20 KHz.

Filter width: user-controllable, either 1/10 or 1/5 oct., Constant Q¹

Resolution: 1/50th Octave

Time required to find and eliminate feedback: 0.4 seconds, typical @ 1KHz

Total number of combined filters active: user selectable, from 1-10

Number of dynamic vs. fixed filters: user selectable

LASTCONFIGURATIONSTOREDINMEMORY

INPUT/OUTPUT²

Input/Output Maximum Signal Levels: Balanced +27dBV peak, unbalanced +21 dBV peak

Output Drive: Unit will perform as specified driving a load >600 Ohms

Input Impedance: Balanced or unbalanced >10K Ohms, PIN 2 high

Output Impedance: Balanced or unbalanced 10 Ohms nominal, PIN 2 high

Bypass: True power off bypass

Headroom: +23dB peak @ 4dBV nominal input, balanced

I/O Connectors: XLR-3 and 1/4" TRS

PERFORMANCE³

Spectral Variation: < .25 dB, 20Hz to 20 KHz

SNR: >100 dB, typical, "A" weighted

THD: <0.02% @ 23 dBV sine wave at 1 KHz

Dynamic Range: >110 dB with ClipGuard™ automatic clip level control active

POWER INPUT

Factory configured to either 115 VAC or 230 VAC. 50/60 Hz, 12 Watt input.

FUSE REPLACEMENT

To reduce the risk of fire, replace only with 5x20 mm, .315 A, 250 V, fast-acting fuse.

DIMENSIONS

1-U rack mount; 19 x 1.75 x 8.0 ins. nominal (rack mountable); 48.3 x 4.5 x 20.3 cm nominal (rack mountable)

WEIGHT

7.0 lbs. (3.3 kg) nominal

OPTIONS

Input/output transformer option

All FBX Feedback Exterminators conform to all Year 2000 (Y2K) standards.

NOTES

¹ Below approximately 200 Hz the feedback filters become slightly wider to increase the feedback and rumble capture speed at these low frequencies.

² Note: Inputs may be balanced or unbalanced. For maximum output capability, outputs must be balanced (XLR or TRS). If either side of an output is grounded, the peak output and dynamic range will be reduced by 6 dB.

³ Tests performed using an Audio Precision System One model 322 or equal.

(SPECIFICATIONS SUBJECT TO CHANGE WITHOUT NOTICE)

FBX-1020 SIMPLIFIED INTERNAL BLOCK DIAGRAM

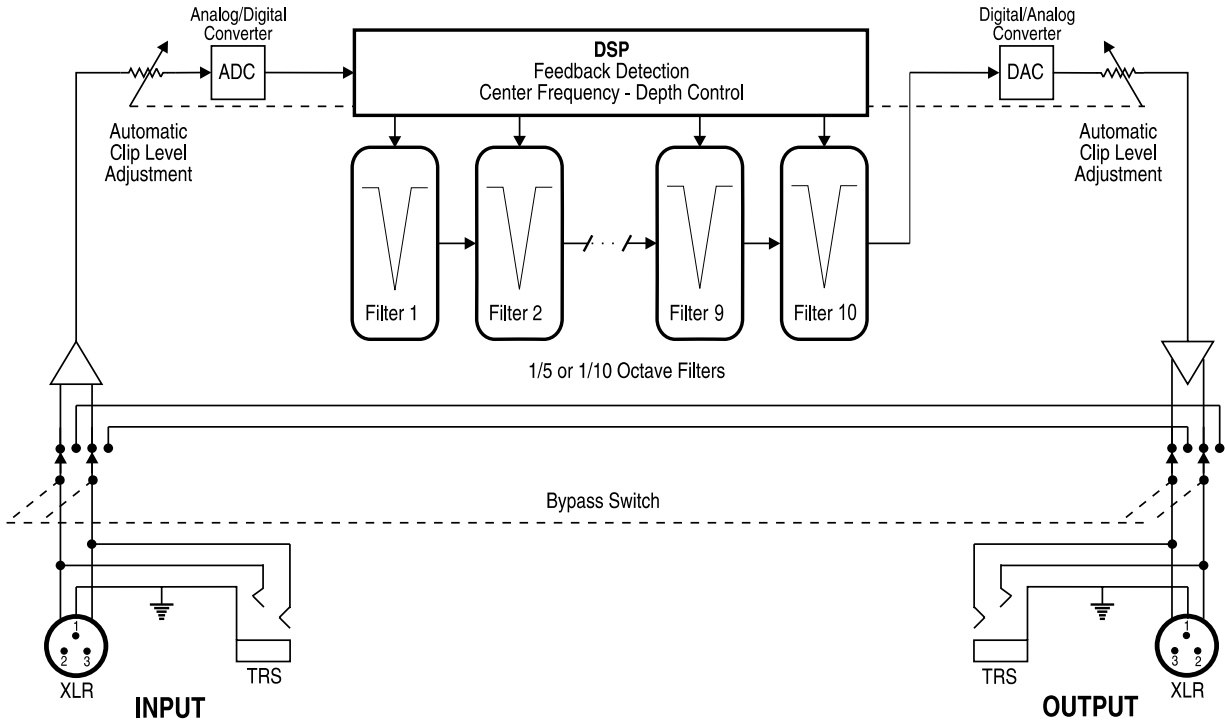

CAUTIONS & WARNINGS

Warning! This equipment must be earthed.

Caution! Risk of electric shock. Do not open.

Caution! Shock hazard. Do not remove covers. No user serviceable parts inside. Refer servicing to qualified service personnel.

Warning! To reduce the risk of fire or electric shock, do not expose this product to rain or moisture.

Attention! Cet appareil doit être relié à la terre.

Attention! Risque de choc électrique; ne pas ouvrir.

Attention! Risque de choc; ne pas ôter les capots. Aucune pièce accessible à l'intérieur. S'adresser à un technicien qualifié.

Attention! Pour réduire le risque d'incendie ou de choc électrique, ne pas laisser l'appareil sous la pluie ou à l'humidité.

Achtung! Dieses Gerät muss schutzgeerdet sein.

Achtung! Gefahr eines elektrischen Stromschlags. Gehäuse nicht öffnen.

Achtung! Gefahr eines elektrischen Stromschlags. Gehäuse nicht öffnen. Keine von Benutzer zu bedienenden Teile im Gerätinneren.

Überlassen Sie das Gerät zu Servicezwecken nur geschultem Fachpersonal. Um Brandgefahr oder das Risiko eines elektrischen Schlags auszuschließen, das Gerät vor Nässe und Feuchtigkeit schützen.

Advertencia! Este equipo debe estar conectado a tierra.

Precaución! Riesgo de descarga eléctrica. No abrir.

Precaución! Riesgo de descarga eléctrica. No desmontar las tapas. Piezas interiores no reparables por el usuario. Reparable sólo por personal cualificado.

Advertencia! Para reducir el riesgo de incendio o de descarga eléctrica no exponga este producto a la lluvia o humedad.

FCC Statement:

This device complies with Part 15, Class B, of the FCC Rules. Operation is subject to the following conditions: (1) This device may not cause harmful interference; and (2) This device must accept any interference received, including interference that may cause undesired operation. *Warning:* Changes or modifications to this unit not expressly approved by the party responsible for compliance could void the user's authority to operate the equipment.

NOTE: This equipment has been tested and found to comply with the limits for a Class B digital device, pursuant to Part 15 of the FCC Rules. These limits are designed to provide reasonable protection against harmful interference in a residential installation. This equipment generates, uses, and can radiate radio frequency energy and, if not installed and used in accordance with the instructions, may cause harmful interference to radio communications. However, there is no guarantee that interference will not occur in a particular installation. If this equipment does cause harmful interference to radio or television reception, which can be determined by turning the equipment off and on, the user is encouraged to try to correct the interference by one or more of the following measures:

- Reorient or relocate the receiving antenna.
- Increase the separation between the equipment and receiver.
- Connect the equipment into an outlet on a circuit different from that to which the receiver is connected.
- Consult the dealer or an experienced radio TV technician for help.

Canadian Compliance Statement

This digital apparatus does not exceed the Class B limits for radio noise emissions from digital apparatus set out in the Radio Interference Regulations of the Canadian Department of Communications.

Le présent appareil numérique n'émet pas de bruits radioélectriques dépassant les limites applicables aux appareils numériques de la class B prescrites dans le Règlement sur le brouillage radioélectrique édicté par le ministre des Communications du Canada.

Japanese EMI Compliance Statement

この装置は、第二種情報装置

(住宅地域又はその隣接した地域において使用されるべき情報装置)で住宅地域での電波障害防止を目的とした情報処理装置等電波障害自主規制協議会 (VCCI) 基準に適合しております。

しかし、本装置をラジオ、テレビジョン受信機に近接してご使用になると、受信障害の原因となることがあります。

取扱説明書に従って正しい取り扱いをして下さい。

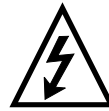

Warning!



The unit is designed to operate from standard AC power. Please be sure the power in your area is compatible with the power requirements marked on the rear of the unit. Using the wrong input voltage may cause permanent damage to the unit and will void the warranty.

The FBX-1020P is supplied with one of the following AC power cords:

Japan	100 VAC
U.S./North America	120 VAC
Continental Europe	230 VAC
United Kingdom	240 VAC
Australia	240 VAC

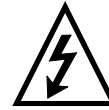

Caution!



Replace the fuse with a fuse of exactly the same rating specified on the rear of the product.

1. Read all safety and operating instructions before using this product.
 2. All safety and operating instructions should be retained for future reference.
 3. Obey all cautions in the operating instructions and on the unit.
 4. All operating instructions should be followed.
 5. Use only shielded audio and data cables.
 6. This product should not be used in the presence of moisture or rain, or near any water, i.e., a bathtub, sink, swimming pool, wet basement, etc.
 7. This product should be located so that its position does not interfere with proper ventilation. Do not use in direct sunlight. Do not place flat against a wall or in a built-in enclosure that will impede the flow of cooling air.
 8. This product should not be placed near a source of heat such as a stove or radiator.
 9. Connect only to a power supply of the type marked on the unit adjacent to the power entry module.
 10. Never break off the ground pin on the power supply cord.
 11. Power supply cords should always be handled carefully. Never walk or place equipment on power supply cords. Periodically check cords for cuts or signs of stress, especially at the plug and the point where the cord exits the unit.
 12. The power supply cord should be unplugged when the unit is to be unused for long periods of time.
 13. Care should be taken so that objects do not fall and liquids are not spilled into the unit through the ventilation holes or any other openings.
 14. This unit should be checked by a qualified service technician if:
 - A. The power supply cord or plug has been damaged.
 - B. Anything has fallen or been spilled into the unit.
 - C. The unit does not operate correctly.
 - D. The unit has been dropped or the enclosure damaged.
 15. The user should not attempt to service this equipment. All service work should be done by a qualified service technician.
- OSHA 2201; 1995 revised.

CAUTION

EXPOSURE TO EXTREMELY HIGH NOISE LEVELS MAY CAUSE A PERMANENT HEARING LOSS. INDIVIDUALS VARY CONSIDERABLY IN SUSCEPTIBILITY TO NOISE INDUCED HEARING LOSS, BUT NEARLY EVERYONE WILL LOSE SOME HEARING IF EXPOSED TO SUFFICIENTLY INTENSE NOISE FOR A SUFFICIENT TIME. THE U.S. GOVERNMENT'S OCCUPATIONAL SAFETY AND HEALTH ADMINISTRATION (OSHA) HAS SPECIFIED THE FOLLOWING PERMISSIBLE NOISE LEVEL EXPOSURES:

DURATION/DAY IN HOURS	SOUND LEVEL IN dBA, SLOW RESPONSE
8	90
6	92
4	95
3	97
2	100
1-1/2	102
1	105
1/2	110
1/4 or less	115

ACCORDING TO OSHA, ANY EXPOSURE IN EXCESS OF THE ABOVE PERMISSIBLE LIMITS COULD RESULT IN HEARING LOSS. EAR PLUGS OR PROTECTORS IN THE EAR CANALS OR OVER THE EARS MUST BE WORN WHEN OPERATING THIS DEVICE IN ORDER TO PREVENT A PERMANENT HEARING LOSS, IF EXPOSURE IS IN EXCESS OF THE LIMITS AS SET FORTH ABOVE. TO ENSURE AGAINST POTENTIALLY DANGEROUS EXPOSURE TO HIGH SOUND PRESSURE LEVELS, IT IS RECOMMENDED THAT ALL PERSONS EXPOSED TO EQUIPMENT CAPABLE OF PRODUCING HIGH SOUND PRESSURE LEVELS SUCH AS THIS DEVICE BE PROTECTED BY HEARING PROTECTORS WHILE THIS UNIT IS IN OPERATION.

FBX and FBX Feedback Exterminator are registered trademarks of Sabine, Inc., and are the brand names of its line of automatic feedback controllers. Covered by U.S. Patent No. 5,245,665, Australian Patent No. 653,736, Canadian Patent No. 2,066,624-2, German Patent No. 69118486.0, and U.K. Patent No. 0486679. Other patents pending.

REAL-Q and REAL-Q2 are protected by U.S. Patent No. 5,506,910. Other patents pending.

Graphi-Q, POWER-Q, REAL-Q, and REAL-Q2 are trademarks of Sabine, Inc.

Copyright 2000. All rights reserved.

ONLINE *Check out what's new!*
product registration
ADAPTIVE AUDIO
www.SabinePro.com

LIMITED WARRANTY

THIS LIMITED WARRANTY VALID ONLY WHEN PURCHASED AND REGISTERED IN THE UNITED STATES OR CANADA. ALL EXPORTED PRODUCTS ARE SUBJECT TO WARRANTY AND SERVICES TO BE SPECIFIED AND PROVIDED BY THE AUTHORIZED DISTRIBUTOR FOR EACH COUNTRY.

Ces clauses de garantie ne sont valables qu'aux Etats-Unis et au Canada. Dans tous les autres pays, les clauses de garantie et de maintenance sont fixées par le distributeur national et assurées par lui selon la législation en vigueur.

Diese Garantie ist nur in den USA und Kanada gültig. Alle Export-Produkte sind der Garantie und dem Service des Importeurs des jeweiligen Landes unterworfen.

Esta garantía es válida solamente cuando el producto es comprado en E.U. continentales o en Canada. Todos los productos que sean comprados en el extranjero, están sujetos a las garantías y servicio que cada distribuidor autorizado determine y otorgue en los diferentes países.

ONE-YEAR LIMITED WARRANTY/REMEDY

SABINE, INC. ("SABINE") warrants this product to be free from defects in material and workmanship for a period of one (1) year from date of purchase PROVIDED, however, that this limited warranty is extended only to the original retail purchaser and is subject to the conditions, exclusions and limitations hereinafter set forth:

CONDITIONS, EXCLUSIONS AND LIMITATIONS OF LIMITED WARRANTIES

These limited warranties shall be void and of no effect if:

- The first purchase of the product is for the purpose of resale; or
- The original retail purchase is not made from an AUTHORIZED SABINE DEALER; or
- The product has been damaged by accident or unreasonable use, neglect, improper service or maintenance, or other causes not arising out of defects in material or workmanship; or
- The serial number affixed to the product is altered, defaced or removed; or
- The power supply grounding pin is removed or otherwise defeated. In the event of a defect in material and/or workmanship covered by this limited warranty, Sabine will repair the defect in material or workmanship or replace the product, at Sabine's option; and provided, however, that, in any case, all costs of shipping, if necessary, are paid by you, the purchaser.

THE WARRANTY REGISTRATION CARD (or ONLINE REGISTRATION FORM) SHOULD BE ACCURATELY COMPLETED, MAILED TO AND RECEIVED BY SABINE WITHIN FOURTEEN (14) DAYS FROM THE DATE OF YOUR PURCHASE.

In order to obtain service under these warranties, you must:

- Bring the defective item to any Authorized SABINE DEALER and present therewith the ORIGINAL PROOF OF PURCHASE supplied to you by the AUTHORIZED SABINE DEALER in connection with your purchase from him of this product. If the DEALER is unable to provide the necessary warranty service, you will be directed to the nearest other SABINE AUTHORIZED DEALER which can provide such service. OR

- Ship the defective item, prepaid, to:

SABINE, INC.
13301 HIGHWAY 441
ALACHUA, FL 32615-8544

Include therewith a complete, detailed description of the problem, together with a legible copy of the original PROOF OF PURCHASE and a complete return address. Upon Sabine's receipt of these items:

If the defect is remedial under the limited warranties and the other terms and conditions expressed have been complied with, Sabine will provide the necessary warranty service to repair or replace the product and will return it, FREIGHT COLLECT, to you, the purchaser.

Sabine's liability to the purchaser for damages from any cause whatsoever and regardless of the form of action, including negligence, is limited to the actual damages up to the greater of \$500.00 or an amount equal to the purchase price of the product that caused the damage or that is the subject of or is directly related to the cause of action. Such purchase price will be that in effect for the specific product when the cause of action arose. This limitation of liability will not apply to claims for personal

injury or damage to real property or tangible personal property allegedly caused by Sabine's negligence. Sabine does not assume liability for personal injury or property damage arising out of or caused by a non-Sabine alteration or attachment, nor does Sabine assume any responsibility for damage to interconnected non-Sabine equipment that may result from the normal functioning and maintenance of the Sabine equipment.

UNDER NO CIRCUMSTANCES WILL SABINE BE LIABLE FOR ANY LOST PROFITS, LOST SAVINGS, ANY INCIDENTAL DAMAGES OR ANY CONSEQUENTIAL DAMAGES ARISING OUT OF THE USE OR INABILITY TO USE THE PRODUCT, EVEN IF SABINE HAS BEEN ADVISED OF THE POSSIBILITY OF SUCH DAMAGES.

THESE LIMITED WARRANTIES ARE IN LIEU OF ANY AND ALL WARRANTIES, EXPRESS OR IMPLIED, INCLUDING BUT NOT LIMITED TO, THE IMPLIED WARRANTIES OF MERCHANTABILITY AND FITNESS FOR A PARTICULAR USE, PROVIDED, HOWEVER, THAT IF THE OTHER TERMS AND CONDITIONS NECESSARY TO THE EXISTENCE OF THE EXPRESS LIMITED WARRANTIES, AS HEREIN ABOVE STATED, HAVE BEEN COMPLIED WITH, IMPLIED WARRANTIES ARE NOT DISCLAIMED DURING THE APPLICABLE ONE-YEAR PERIOD FROM DATE OF PURCHASE OF THIS PRODUCT.

SOME STATES DO NOT ALLOW LIMITATION ON HOW LONG AN IMPLIED WARRANTY LASTS, OR THE EXCLUSION OR LIMITATION OF INCIDENTAL OR CONSEQUENTIAL DAMAGES, SO THE ABOVE LIMITATIONS OR EXCLUSIONS MAY NOT APPLY TO YOU. THESE LIMITED WARRANTIES GIVE YOU SPECIFIC LEGAL RIGHTS, AND YOU MAY ALSO HAVE OTHER RIGHTS WHICH MAY VARY FROM STATE TO STATE.

THESE LIMITED WARRANTIES ARE THE ONLY EXPRESS WARRANTIES ON THIS PRODUCT, AND NO OTHER STATEMENT, REPRESENTATION, WARRANTY OR AGREEMENT BY ANY PERSON SHALL BE VALID OR BINDING UPON SABINE.

In the event of any modification or disclaimer of express or implied warranties, or any limitation of remedies, contained herein conflicts with applicable law, then such modification, disclaimer or limitation, as the case may be, shall be deemed to be modified to the extent necessary to comply with such law.

Your remedies for breach of these warranties are limited to those remedies provided herein, and Sabine gives this limited warranty only with respect to equipment purchased in the United States of America.

INSTRUCTIONS-WARRANTY REGISTRATION CARD

Mail the completed WARRANTY REGISTRATION CARD to:

SABINE, INC.
13301 HIGHWAY 441
ALACHUA, FL 32615-8544

OR, register online at www.SabinePro.com

NOTE: Keep the PROOF OF PURCHASE. In the event warranty service is required during the warranty period, you will need this document. There will be no identification card issued by Sabine, Inc. **IMPORTANCE OF WARRANTY REGISTRATION CARDS AND NOTIFICATION OF CHANGES OF ADDRESS**

Should notification become necessary for any condition that may require correction, the REGISTRATION CARD, or information submitted using the ONLINE REGISTRATION FORM, will help ensure that you are contacted and properly notified.

Notice of address changes - If you move from the address shown on the WARRANTY REGISTRATION CARD or ONLINE REGISTRATION FORM, you should notify Sabine of the change of address so as to facilitate your receipt of any bulletins or other forms of notification which may become necessary in connection with any condition that may require dissemination of information or correction.

You may contact Sabine directly by telephoning (904) 418-2000.

Please have the Sabine product name and serial number available when communicating with Sabine Customer Service.